

# MODEL: LTOW5030 L/R

# ESCAPE

SHOWN WITH OPTIONAL THREE PIECE WALL SURROUND AND DECK EXTENSION

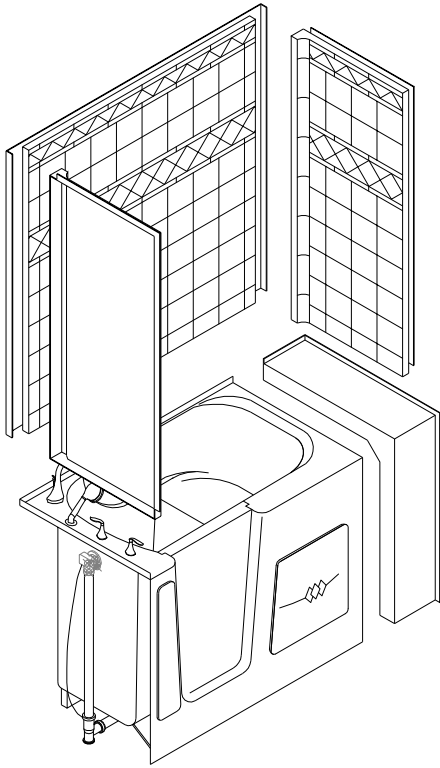

**PERSPECTIVE VIEW - N.T.S.  
MODEL SHOWN HERE AS:  
LEFT HAND**

## Features:

- Designed to fit in the space of your current bathtub
- Seat height is designed for ease of sitting and standing
- Extra deep for a full body soak
- Innovative new door handle designed for easy operation
- Reliable door seal that comes with a lifetime warranty
- Heated seat for comfort while filling and draining
- Tile Look Wall surround system with integral plywood backing and SnapJoint for quick assembly
- Allows you the freedom to rehabilitate at home
- Space under tub allows for "reverse" plumbing.

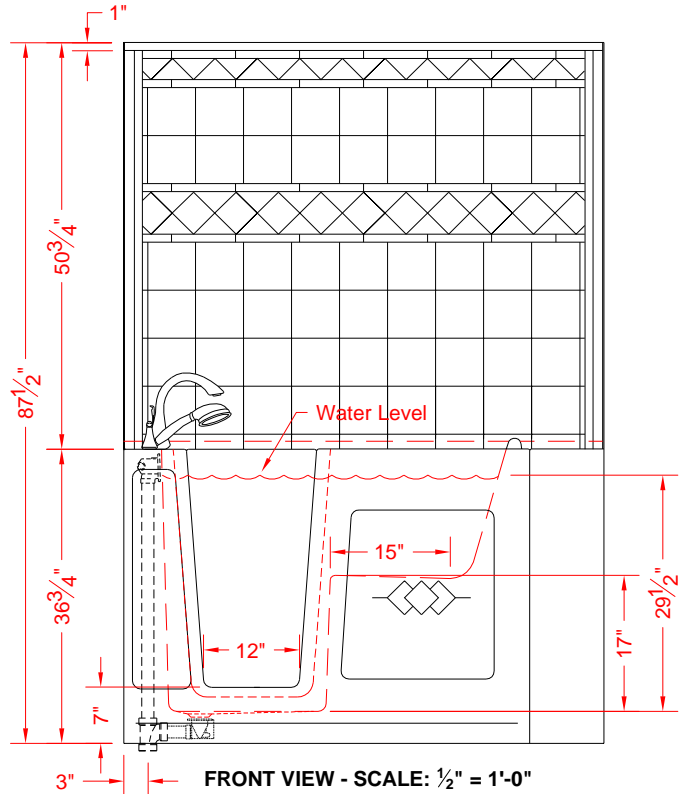
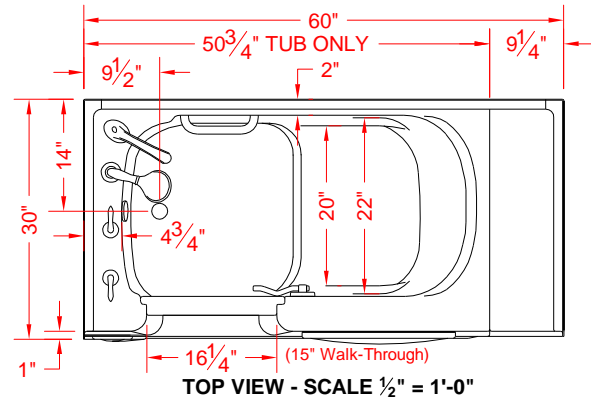

## PRODUCT SPECIFICATIONS:

- Walk-in bathtub with pressure sealed door shall be of gelcoat / fiberglass construction and have an integral front skirt, magnetically attached access panels for plumbing and deck/skirt extension.
  - The matching wall system shall have integral plywood backing and a SnapJoint assembly feature.
- C.S.I. FORMAT SPECIFICATION TEXT AVAILABLE

## PRODUCT INFORMATION:

- Accessories: Factory installed Tub Bar and optional plumbing rough-in, all others installed by others
- Colors: White as standard, Almond optional
- Also available with sprayable solid surface in many colors
- Fill volume with a 170 lbs. bather: 59 gallons
- Tub weight, dry, approx. 134 lbs.
- Total weight of tub, bather, and water: approx. 794 lbs.

Power Requirements:  
Heated Seat 120V/15A (draws 0.2A)

## ACCESSORIES:

- STANDARD:**
- Tub bar
  - Cable operated tub drain
- OPTIONAL:**
- Roman tub filler
  - Hand shower
  - Thermostatic mixing valve
  - Grab bars for installation on wall surround
  - Custom Tile Accenting on Wall
  - Window trim kit
  - Flange trim kit

## CODES:

Designed and manufactured in compliance with the following standards and codes:

- I.A.P.M.O. / A.N.S.I. Z124.1.2-2005 Plastic Bathtubs and Showers
- A.S.M.E. A112.19.15-2001 Bathtubs / Whirlpool Bathtubs with pressure sealed doors



DIV. OF FIBERGLASS SYSTEMS INC.  
www.best-bath.com 1-800-727-9907

We reserve the right to make revisions without notice in the design of fixtures or in packaging unless this right has specifically been waived at the time the order is accepted.

# ESCAPE / ESCAPE PLUS WALK-IN BATHTUB CONFIGURATIONS AVAILABLE:

①

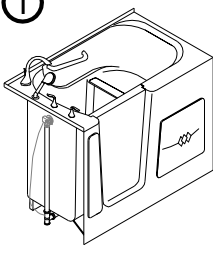

- No additional accessories included.

②

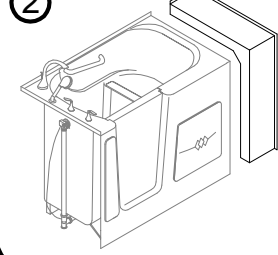

- With Deck Extension
- Fits in the space of a typical 5 ft. bathtub or shower
- Generally for an ALCOVE installation.

Escape Deck Extension  
Model # ESC-1000 (RH) / ESC-1001 (LH)

③

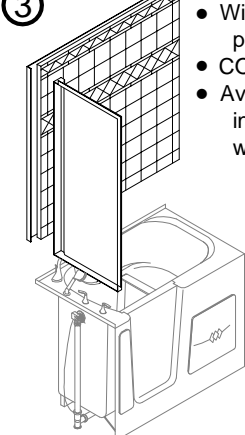

- With two walls: a back wall and a plumbing side wall.
- CORNER installation
- Available for all standard configurations in both SnapJoint\* and Universal\*\* wall systems.

\* SnapJoint  
Model # 2WIDWS5030 L/R

\*\* Universal  
Model # 2DWSU6030 L/R

④

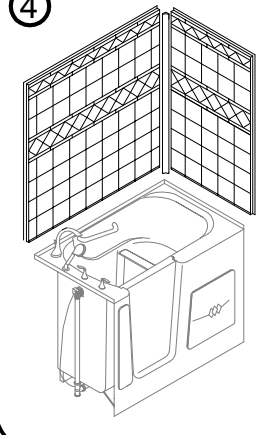

- With two walls: a back wall and an opposite plumbing side wall.
- Reverse CORNER installation
- Available for custom configurations in both SnapJoint\* and Universal\*\* wall systems.
- This configuration requires an add-on nailing flange.

\* SnapJoint  
Model # 2WIDWS5030 L/R

\*\* Universal  
Model # 2DWSU6030 L/R

⑤

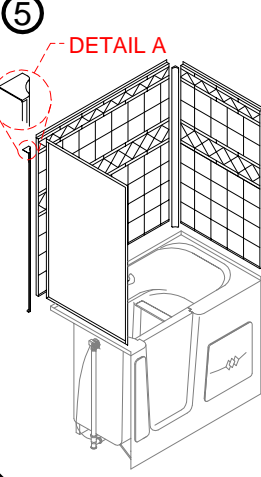

- With three walls: a back wall and two side walls.
- ALCOVE installation for a framing pocket of 50-3/4" x 30"
- Available for custom configurations or new construction in the Universal\*\* wall system only.
- This configuration requires an add-on nailing flange.

\*\* Universal  
Model # 3DWSU6030

⑥

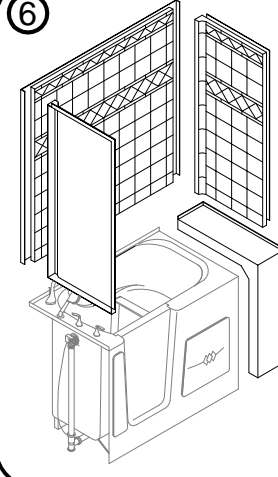

- With Deck Extension and three walls: a back wall and two side walls.
- ALCOVE installation for a framing pocket of 60" x 30"
- Available for all standard configurations in both SnapJoint\* and Universal\*\* wall systems.

\* SnapJoint  
Model # 3WIDWS6030

\*\* Universal  
Model # 3DWSU6030

Escape Deck Extension  
Model # ESC-1000 (RH) / ESC-1001 (LH)

## \*SnapJoint Wall System:

- Standard wall system for square framing
- Designed to fit all installation scenarios other than option # 5
- Quick, easy "snap-in" installation

## \*\*Universal Wall System (including Corner Trim: DETAIL A in option # 5) can be cut to accommodate:

- Option # 5
- Any configuration with out-of-square walls or framing
- Other unusual situations



*We reserve the right to make revisions without notice in the design of fixtures or in packaging unless this right has specifically been waived at the time the order is accepted.*